

## Canale attrezzato

Canali attrezzati

Codice: 3024 880



### DETTAGLI

Bordo Installazione	Sottotop
Materiale	Acciaio inox AISI 304
Finitura	Spazzolato Foster
Texture	Spazzolatura in linea
Base	60 cm
Dimensioni esterne	438 x 170 mm
Dimensioni interne	422 x 122 mm
Larghezza	43,8 cm
Lunghezza	3 unità - Standard

Foro incasso

Vedi scheda tecnica

---

Dotazioni standard

Viti di fissaggio, piletta, imballo in scatola

---

Piletta

Piletta 1¼"

---

Chiave di lettura per gli accessori

Le lunghezze dei canali e degli accessori sono indicate in "unità", per la composizione la somma delle "unità" degli accessori deve corrispondere alla lunghezza in "unità" del canale.

---

## DATI TECNICI

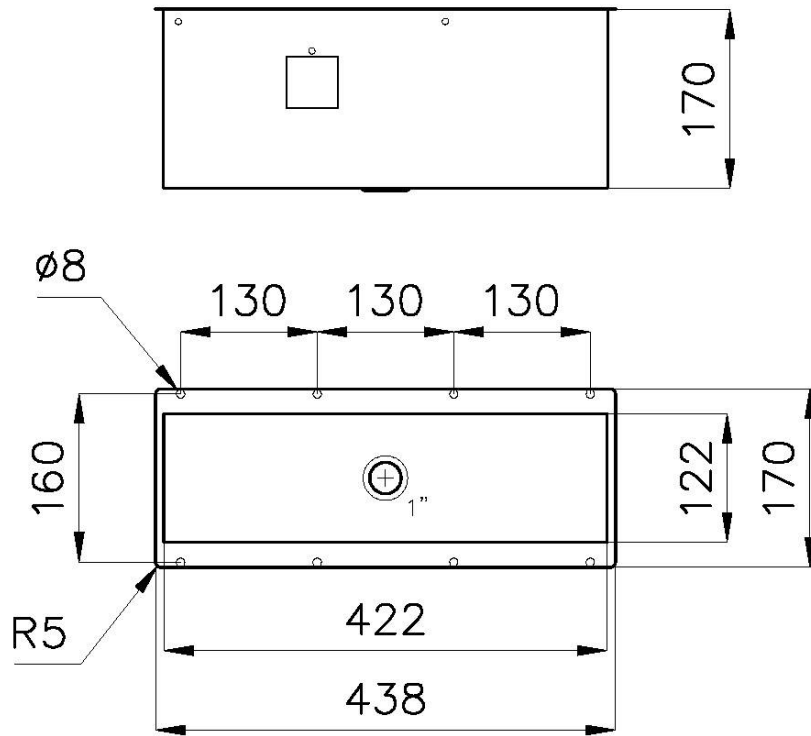

## Sottotop/Undermount

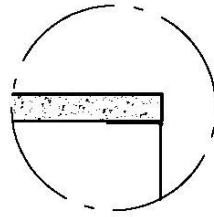

B-B:  
Dettaglio installazione  
Installation detail

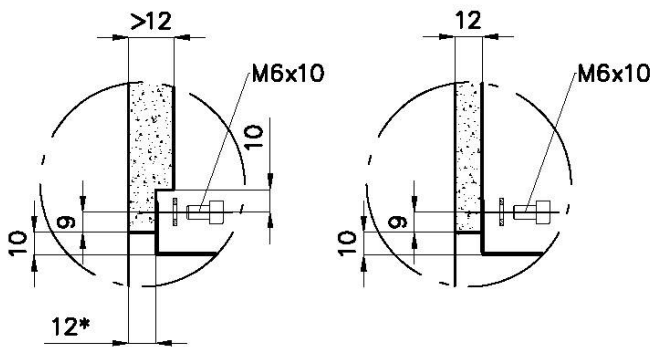

A-A:  
Dettaglio installazione positive reveal e sistema di fissaggio  
Installation detail with positive reveal and fixing system

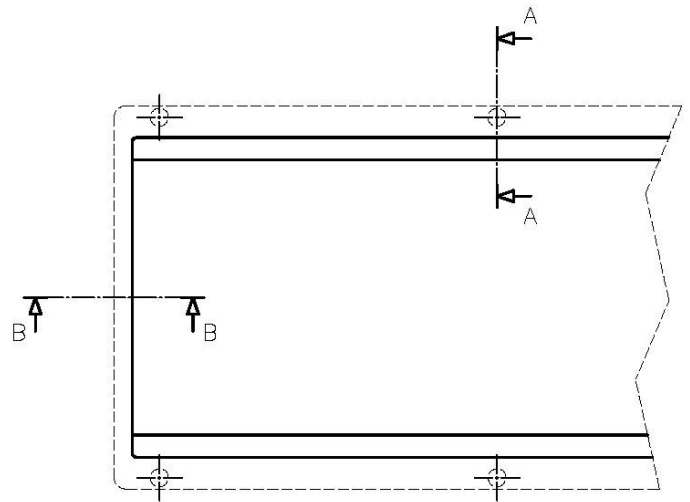

\*spessore consigliato per un abbinamento perfetto con gli accessori  
\*recommended thickness for a perfect match with the accessories

Dimensioni per foratura top  
Cut out size

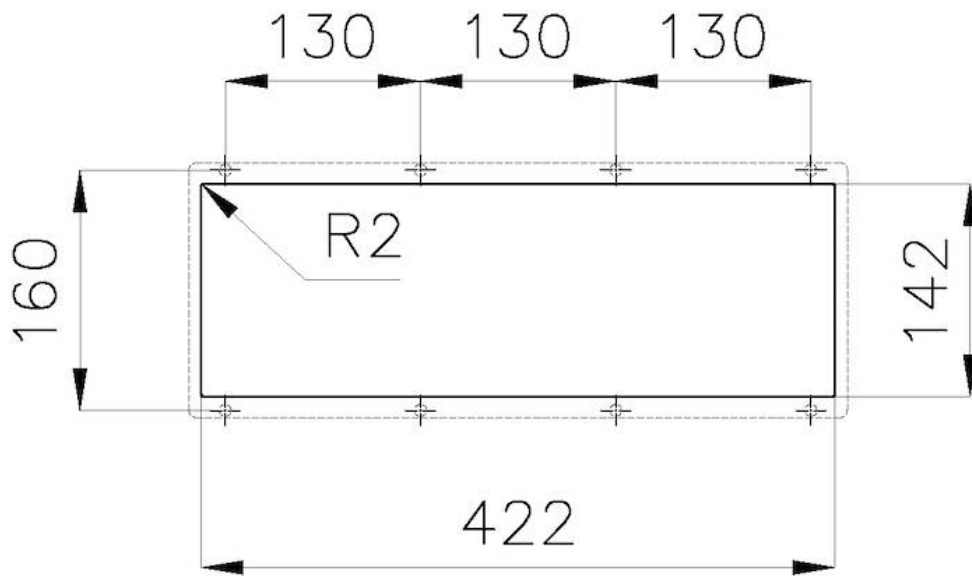

## GALLERIA FOTOGRAFICA

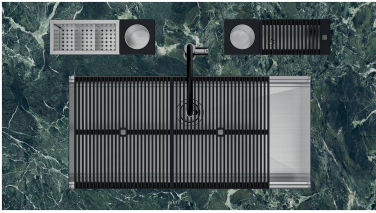

## ACCESSORI OPZIONALI



**Gocciolatoio Black**  
8100 058



**Kit "A"**  
8100 703



**Kit "B"**  
8100 700



**Kit "C"**  
8100 701



**Kit "D"**  
8100 704



**Kit "E"**  
8100 705



**Kit "F"**  
8100 706



**Kit "G"**  
8100 710



**Kit "H"**  
8100 702



**Kit "N"**  
8100 714



**Portacoltelli inox**  
8100 712



**Portapiatti inox**  
1773 100



**Portaprese inox**  
8000 020



**Vaschetta forata inox**  
8151 003